

STM32F407 Discovery

Vhodno / izhodne naprave

SysTick Časovnik

STM32F407VG

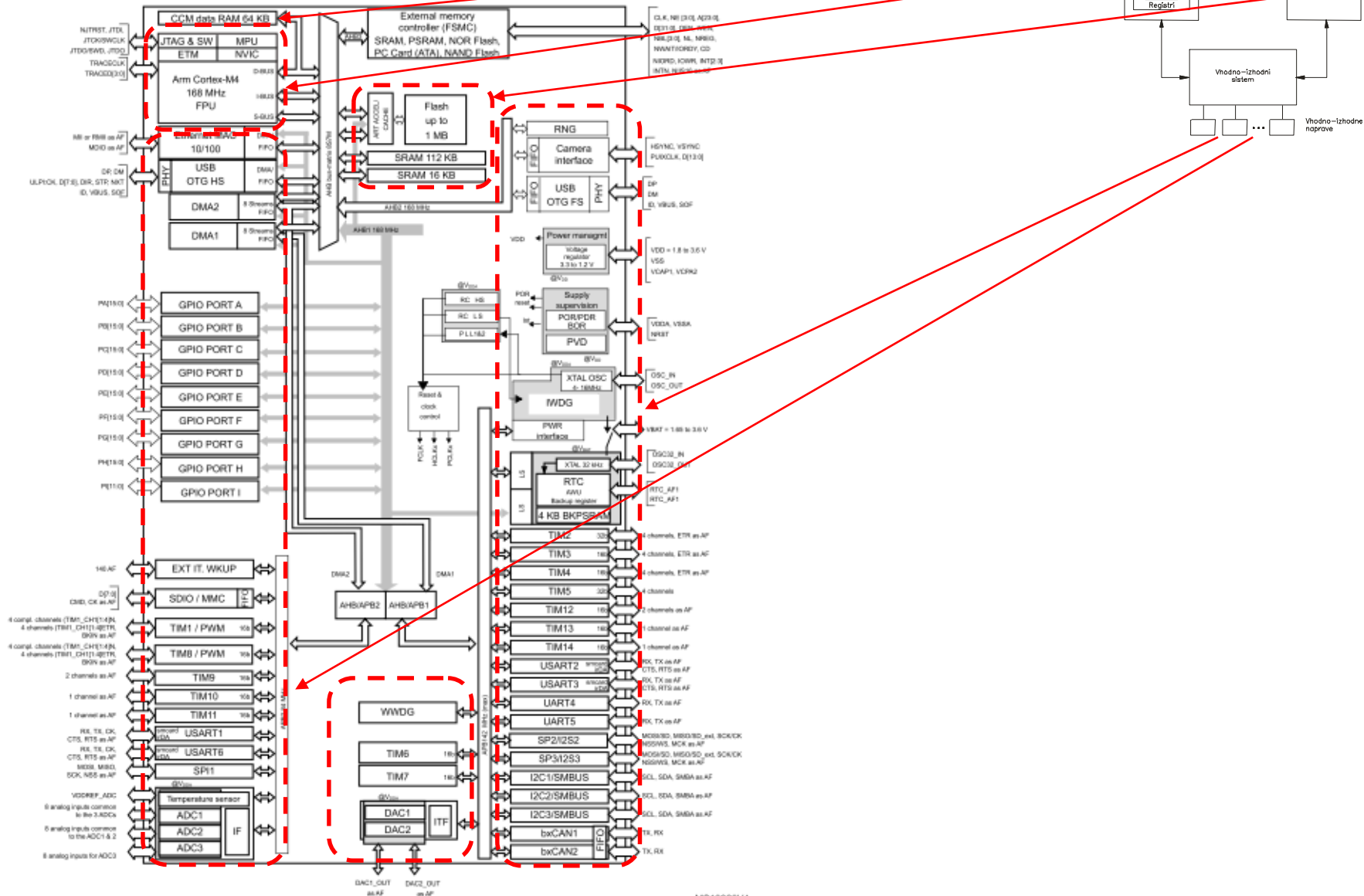

MS19820V4

Delo na STM32F4 razvojnem sistemu

Priključitev :

- **Mini USB** prikllop na **krajši stranici**, svetila rdeči **LED** diodi

Poseben začetni projekt za STM32F4 (e-učilnica) :

- **dodajanje vsebine (template.s) :**

'template.s - STM32CubeIDE

avigate Search Project Run Window Help

```
template.s
54
55 _start:
56 // Enable GPIO Peripheral Clock (bit 3 in AHB1ENR register)
57 ldr r6, = RCC_AHB1ENR // Load peripheral clock reg address to r6
58 ldr r5, [r6] // Read its content to r5
59 orr r5, #0x00000008 // Set bit 3 to enable GPIO clock
60 str r5, [r6] // Store result in peripheral clock register
61
62 // Make GPIO Pin12 as output pin (bits 25:24 in MODER register)
63 ldr r6, = GPIO_MODER // Load GPIO MODER register address to r6
64 ldr r5, [r6] // Read its content to r5
65 bic r5, #0x3000000 // Clear bits 24, 25 for P12
66 orr r5, #0x01000000 // Write 01 to bits 24, 25 for P12
67 str r5, [r6] // Store result in GPIO MODER register
68
69 // Set GPIO Pin12 to 1 (bit 12 in ODR register)
70 ldr r6, = GPIO_ODR // Load GPIO output data register
71 ldr r5, [r6] // Read its content to r5
72 orr r5, #0x1000 // write 1 to pin 12
73 str r5, [r6] // Store result in GPIO output data register
74
75 // Set GPIO Pin12 to 0 (bit 12 in ODR register)
76 ldr r6, = GPIO_ODR // Load GPIO output data register
77 ldr r5, [r6] // Read its content to r5
78 bic r5, #0x1000 // write 0 to pin 12
79 str r5, [r6] // Store result in GPIO output data register
80
81 loop:
82 nop // No operation. Do nothing.
83 b loop // Jump to loop
84
```



STM32 CubeIDE, STM32F4 (izbrana dokumentacij

----- Razvojni sistem -----

STM32 CubeIDE

ORLab-STM32 - GitHub repozitorij

User Manual Discovery kit stm32f407vg Uploaded 8/11/21, 12:58

DataSheet_stm32f407vg Uploaded 8/11/21, 12:56

Reference Manual rm0090-stm32f407417 Uploaded 8/11/21, 12:57

Programming_Manual_pm0214-stm32-cortexm4-mcus-and-mpu

Arm Cortex-M4 Processor Datasheet Short Uploaded 29/10/21, 15:00

----- Cortex-M arhitektura, zbirnik -----

ARM Cortex-M for Beginners ARM 2017 Uploaded 29/10/21, 14:50

Časovniki

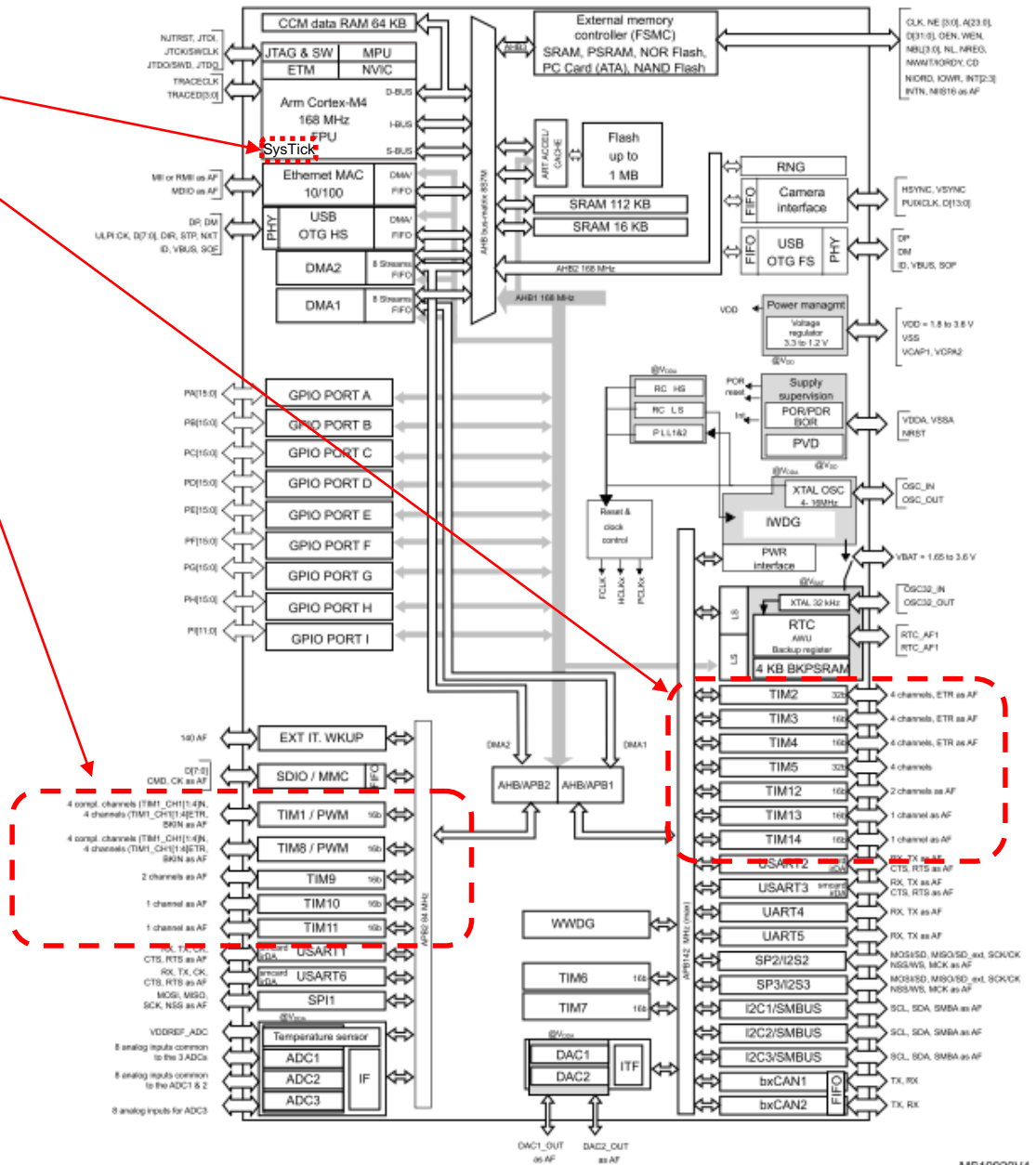

MS19920V4

Vira: Reference & Programming manuals



PM0214 Programming manual

STM32 Cortex[®]-M4 MCUs and MPUs programming manual

Core peripherals

4.5 SysTick timer (STK)

Table 54. System timer registers summary

Address	Name	Type	Required privilege	Reset value	Description
0xE000E010	STK_CTRL	RW	Privileged	0x00000000	SysTick control and status register (STK_CTRL) on page 247
0xE000E014	STK_LOAD	RW	Privileged	Unknown	SysTick reload value register (STK_LOAD) on page 248
0xE000E018	STK_VAL	RW	Privileged	Unknown	SysTick current value register (STK_VAL) on page 249
0xE000E01C	STK_CALIB	RO	Privileged	0xC0000000	SysTick calibration value register (STK_CALIB) on page 250



RM0090 Reference manual

STM32F405/415, STM32F407/417, STM32F427/437 and STM32F429/439 advanced Arm[®]-based 32-bit MCUs

- 17 **Advanced-control timers (TIM1 and TIM8)**
- 18 **General-purpose timers (TIM2 to TIM5)**
- 19 **General-purpose timers (TIM9 to TIM14)**
- 20 **Basic timers (TIM6 and TIM7)**
- 21 **Independent watchdog (IWDG)**
- 22 **Window watchdog (WWDG)**

SysTick časovnik – stanje, nastavitve

4.5.6 SysTick register map

The table provided shows the SysTick register map and reset values. The base address of the SysTick register block is **0xE000 E010**

Table 55. SysTick register map and reset values

Offset	Register	31	30	29	28	27	26	25	24	23	22	21	20	19	18	17	16	15	14	13	12	11	10	9	8	7	6	5	4	3	2	1	0
0x00	STK_CTRL	Reserved																Reserved										1	0	0			
	Reset Value																											0	1	0			
0x04	STK_LOAD	Reserved		RELOAD[23:0]																													
	Reset Value			0 0 0 0 0 0 0 0 0 0 0 0 0 0 0 0 0 0 0 0 0 0 0 0 0 0 0 0 0 0 0 0 0 0																													
0x08	STK_VAL	Reserved		CURRENT[23:0]																													
	Reset Value			0 0 0 0 0 0 0 0 0 0 0 0 0 0 0 0 0 0 0 0 0 0 0 0 0 0 0 0 0 0 0 0 0 0																													
0x0C	STK_CALIB	Reserved		TENMS[23:0]																													
	Reset Value			0 0 0 0 0 0 0 0 0 0 0 0 0 0 0 0 0 0 0 0 0 0 0 0 0 0 0 0 0 0 0 0 0 0																													

Osnovni registri za delovanje SysTick časovnika:

STK_CTRL : vklop časovnika

CLKSOURCE=1, ENABLE=1

COUNTERFLAG=1, ko prešteje do 0 (postavi na STK_LOAD in nadaljuje)

STK_LOAD : zač. vrednost štetja (šteje proti 0)

STK_LOAD = število period

STK_VAL : trenutna vrednost števca

STK_VAL = nekje med STK_LOAD in 0

SysTick časovnik (Registri za nastavitve delovanja)

4.5.1 SysTick control and status register (STK_CTRL)

Address offset: 0x00

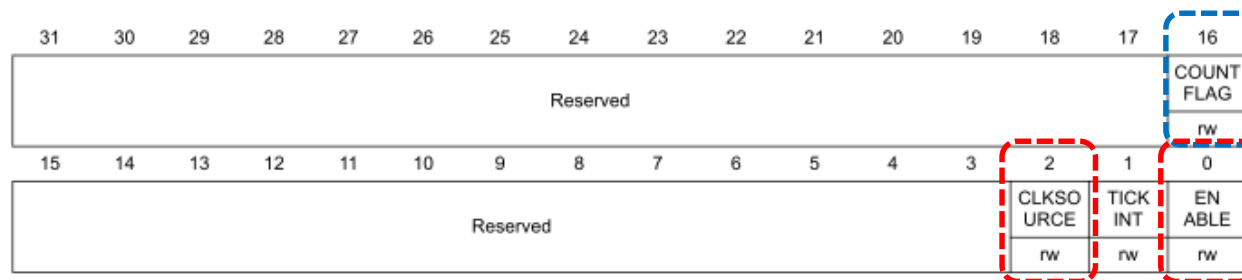

Bit 16 **COUNTFLAG**:

Returns 1 if timer counted to 0 since last time this was read.

Bits 15:3 Reserved, must be kept cleared.

Bit 2 **CLKSOURCE**: Clock source selection

Selects the clock source.

0: AHB/8

1: Processor clock (AHB)

Bit 1 **TICKINT**: SysTick exception request enable

0: Counting down to zero does not assert the SysTick exception request

1: Counting down to zero asserts the SysTick exception request.

Note: Software can use COUNTFLAG to determine if SysTick has ever counted to zero.

Bit 0 **ENABLE**: Counter enable

Enables the counter. When ENABLE is set to 1, the counter loads the RELOAD value from the LOAD register and then counts down. On reaching 0, it sets the COUNTFLAG to 1 and optionally asserts the SysTick depending on the value of TICKINT. It then loads the RELOAD value again, and begins counting.

0: Counter disabled

1: Counter enabled

SysTick časovnik (Registri za nastavitve delovanja)

4.5.2 SysTick reload value register (STK_LOAD)

Address offset: 0x04

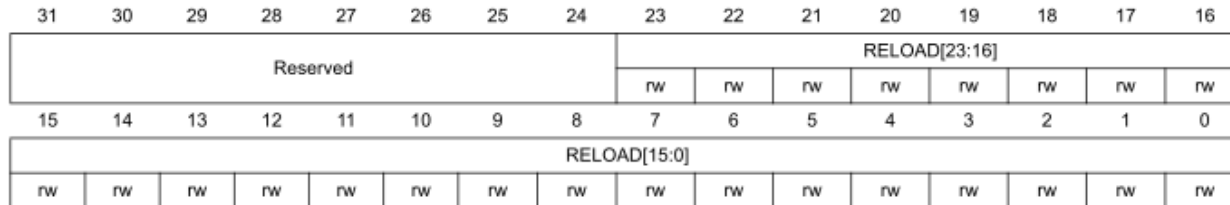

Bits 31:24 Reserved, must be kept cleared.

Bits 23:0 **RELOAD**: RELOAD value

The LOAD register specifies the start value to load into the STK_VAL register when the counter is enabled and when it reaches 0.

Calculating the RELOAD value

The RELOAD value can be any value in the range 0x00000001-0x00FFFFFF. A start value of 0 is possible, but has no effect because the SysTick exception request and COUNTFLAG are activated when counting from 1 to 0.

The RELOAD value is calculated according to its use:

- | To generate a multi-shot timer with a period of N processor clock cycles, use a RELOAD value of N-1. For example, if the SysTick interrupt is required every 100 clock pulses, set RELOAD to 99.
- | To deliver a single SysTick interrupt after a delay of N processor clock cycles, use a RELOAD of value N. For example, if a SysTick interrupt is required after 100 clock pulses, set RELOAD to 99.

SysTick časovnik (*Registri za nastavitve delovanja*)

4.5.3 SysTick current value register (STK_VAL)

Address offset: 0x08

Reset value: 0x0000 0000

Required privilege: Privileged

31	30	29	28	27	26	25	24	23	22	21	20	19	18	17	16	
Reserved								CURRENT[23:16]								
								rw	rw	rw	rw	rw	rw	rw	rw	rw
15	14	13	12	11	10	9	8	7	6	5	4	3	2	1	0	
CURRENT[15:0]																
rw	rw	rw	rw	rw	rw	rw	rw	rw	rw	rw	rw	rw	rw	rw	rw	

Bits 31:24 Reserved, must be kept cleared.

Bits 23:0 **CURRENT**: Current counter value

The VAL register contains the current value of the SysTick counter.

Reads return the current value of the SysTick counter.

A write of any value clears the field to 0, and also clears the COUNTFLAG bit in the STK_CTRL register to 0.

SysTick Časovnik – krmiljenje

Potrebni koraki za krmiljenje časovnika SysTick:

1. **STK_LOAD** (Reload Value Register): **Value** SYSTICK_RELOAD_1MS
2. **STK_VAL** (Current Value Register): **0, reset to zero**
3. **STK_CTRL** (Control/Status Register): **0b101 : Proc. Clock, enable**
-> **Start SysTick**



4. Delovanje:

Čakanje na pojavitev COUNT_FLAG=1 (b₁₆) v STK_CTRL





















Naslovi registrov:

```
// RCC base address is 0x40023800
// AHB1ENR register offset is 0x30
.equ RCC_AHB1ENR, 0x40023830 // RCC AHB1 peripheral clock reg (page 180)

// SysTick Timer definitions
.equ SCS_BASE, 0xe000e010
.equ STK_STRL, 0x00 // Control/Status register
.equ STK_LOAD, 0x04 // Value to countdown from
.equ STK_VAL, 0x08 // Current value
```

CubeIDE – Registers okno

Name	Value
▼  General Registers	
 r0	0x0
 r1	0x0
 r2	0x0
 r3	0x0
 r4	0x0
 r5	0x1000
 r6	0x40020c14
 r7	0x0
 r8	0x0
 r9	0x0
 r10	0x0
 r11	0x0
 r12	0x0
 sp	0x20020000
 lr	0xffffffff
 pc	0x800002a
 xpsr	0x41000000

CubeIDE – SFR okno

(x)= Variables Breakpoints Expressions Disassembly Registers Live Expressions SFRs

RD | X16 X10 X2

type filter text

Register	Address	Value
> 0101 Control		
> 0101 FPE		
> 0101 ID		
> 0101 MPU		
> 0101 NVIC		
> 0101 NVIC_STIR		
▼ 0101 SysTick		
> 0101 STCSR	0xe000e010	0x5
> 0101 STRVR	0xe000e014	0x3e7f
> 0101 STCVR	0xe000e018	0x3e77
> 0101 STCR	0xe000e01c	0x4000493e
▼ STM32F407		
> 0101 RNG		
> 0101 DCMI		
> 0101 FSMC		
> 0101 DBG		

Device: Cortex_M4
Version: 1.2

Description:
Cortex-M4 core descriptions, generated from ARM developer studio